

JEEVES COLLECTION

INSTALLATION GUIDE



- These units should be installed by a certified electrician in accordance with the National Electrical Code (NEC) and the Canadian Electrical Code (CEC).
- The unit requires a 120 volt, 60Hz power source and should be installed on a GFCI protected circuit.
- An on/off switch or other hardwired control mechanism must be used to operate unit - if wired directly unit will remain on indefinitely which is not recommended.
- Follow installation instructions to ensure unit is securely fixed to wall.
- Unit **MUST NOT** be installed upside down: The electrical supply should be located at the bottom of the unit for correct installation.
- Unit is designed for hanging, drying and warming towels or other articles of clothing: Under no circumstances should anybody climb on or hang on unit.
- Unit is intended for indoor use, and whilst they can be used outdoors in suitable conditions, the warranty would be voided.
- Do not place units inside a shower, sauna, steam room, or wherever unit would be exposed to water, unless you have also purchased and installed our UL Certified wet-rated installation kit, sold separately (SKU: AJ-WRK).
- Surface temperature can increase depending on the ambient temperature in the room and the number of towels applied to the unit.
- The fasteners provided with the installation kit are for convenience only and are not suitable for all installations.
- To ensure the Heated Towel Rail is mounted securely, fasteners should be secured in studs or structural members placed behind the rails.
- It is the ultimate responsibility of the installer to ensure proper mounting hardware is employed in attaching the unit to the wall.
- After installation, connect the electric power.
- Allow 30-45 minutes to heat up.
- This rack is designed and safe to run continuously with a simple on/off switch for control. However, it can also be wired to a timer for scheduled control.
- Towels which contain soap or detergent residue may appear to have scorch marks; this is simply discoloration of the residue. These discoloration marks will disappear after a couple wash cycles.
- The unit is constructed from extremely durable 304 stainless steel. To maintain a good appearance, follow these simple instructions:
 - > For routine cleaning, simply switch off the unit, allow to cool to room temperature, wipe with a damp cloth and buff with a soft, dry cloth.
 - > Under no circumstances should abrasive cleaners be used to clean the unit.
 - > View our cleaning and maintenance guidelines found on our website for further information.

WARRANTY

A ten-year limited warranty on the unit and two years on the element will apply with proof of purchase if all Terms and Conditions of Sale are met, and Installation Instructions are adhered to.

MOUNTING LEG ASSEMBLY

Loosen the set screw **D** to release tapered bushing **F** from Leg Extension **B**



INCLUDED COMPONENTS

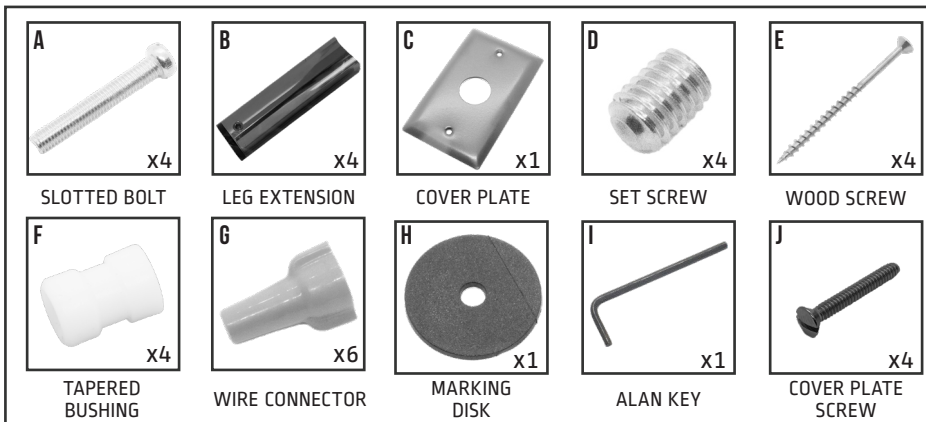

TOOLS REQUIRED

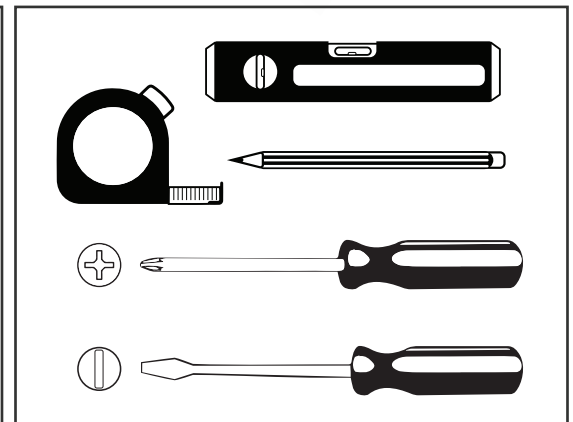

FOR DIMENSIONS AND SPECS, VISIT MODEL PAGE ON OUR WEBSITE FOR TECHNICAL DRAWING

www.ambaproducts.com | customerservice@ambaproducts.com | [404] 350-9738

JEEVES COLLECTION

INSTALLATION GUIDE



FOR DIMENSIONS AND SPECS, VISIT MODEL PAGE ON OUR WEBSITE FOR TECHNICAL DRAWING

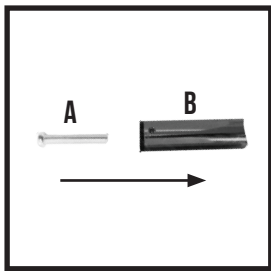

FIG 1

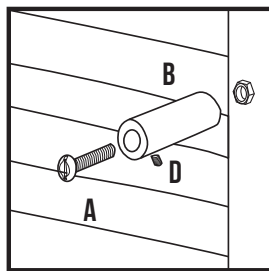

FIG 2

STEP 1

Insert the slotted bolt [part A] through the leg extension [part B], as shown in [fig. 1], for all 4 leg extensions. Fasten the bolt into the threaded nut welded onto the back of the unit, using a flat head screw driver, as shown in [fig. 2]. *Note - make sure the set screw [part D] on the leg extension is facing down, do not tighten yet.

Decide where to install unit and the location of the single gang junction box. This can be done by either placing the assembled rack against the wall or taking approximate dimensions from the drawing supplied.

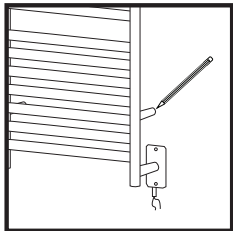

FIG 3

STEP 2

Install single gang junction box in the desired position. Secure supplied cover plate onto box. Place unit against wall with wire cover tube inserted in cover plate. To achieve this, the cord needs to be fed through the slot at the end of the tube. Make sure the unit is mounted squarely and levelled. Use a pencil to lightly mark the position of all four leg extensions on the wall [fig. 3].

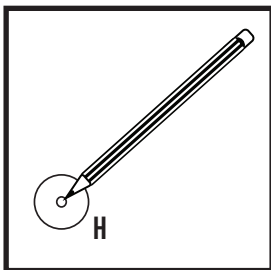

FIG 4

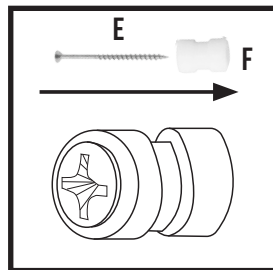

FIG 5

STEP 3

Remove unit and center the marking disk [part H] in the circles marked on the wall in Step 2. Mark the center of the hole using a pencil. Repeat for all legs. Place the tapered bushing [part F] onto the center of the circles marked in [fig. 4], insert supplied wood screw through center of the tapered bushing and fasten to wall as in [Fig 5]. If rack is installed on a tiled surface use a toggle bolt anchor. If mounting to drywall without wood backing, drywall anchors or toggle bolt anchors are also recommended.

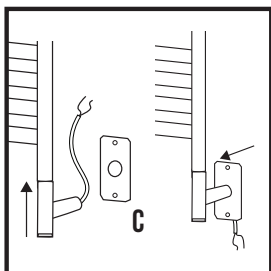

FIG 6

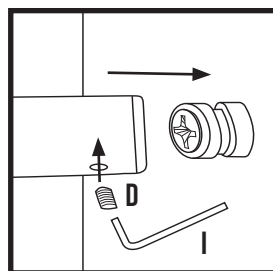

FIG 7

STEP 4

Slide cover plate [part C] over tube with electrical wires [fig. 6] and make the electrical connections as outlined in the diagram below [fig. 8], using the provided wire connectors [part g]

Slide unit with leg extensions onto the 4 tapered bushings and using the supplied allen key [part I], tighten the set screw [part D] on all four legs to secure the unit to wall.

After properly securing all wire connections, push wires into box and secure cover plate to the junction box with provided cover plate screws

WIRING DIAGRAM

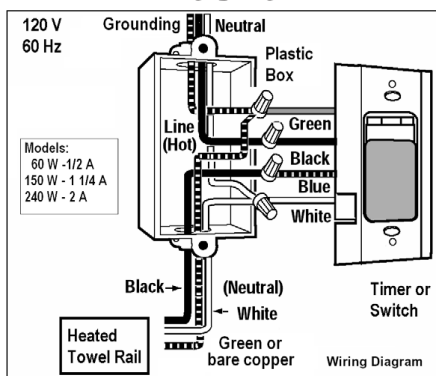

FIG 8

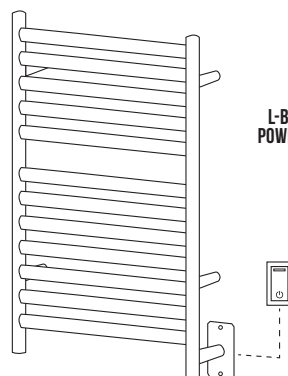
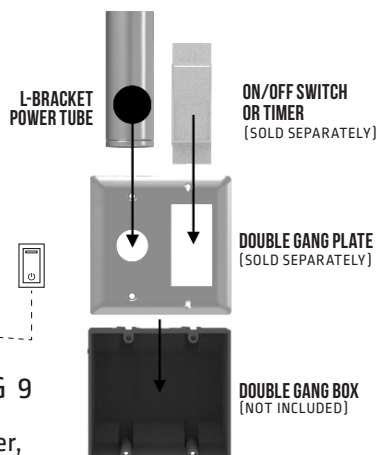

FIG 9



Jeeves Collection models can be installed with an optional Double Gang Plate [fig. 10], replacing the included Single Gang Plate and allowing a switch or timer to be integrated directly adjacent to the rack itself.



FIG 10

The towel rack must be connected to an on/off switch or a timer, [see fig. 9]. Make sure one is provided for installation. The heated towel rack will not perform if a timer with cycles shorter than 30min is used.