

Installation Instructions

Single Pole (One location) or
3-Way (Multi-location)

DECORA 24-HOUR PROGRAMMABLE TIMER

LED and CFL Compatible

1800W Incandescent - 15A Fluorescent Ballast
600W CFL/LED, 1HP Motor
120VAC, 60Hz

Tools Needed to Install Your Timer Switch

- Slotted/Phillips Screwdriver
- Pencil
- Electrical Tape
- Cutters
- Pliers
- Ruler

Changing the Color of Your Device:

Your device may include color options. To change the color of the cover, proceed as follows:

1. Push the tabs on one side of the device inward, and then pull the cover outward to release it from the device.
2. Line up the tabs on one side with their openings, and then push in the tabs on the other side.

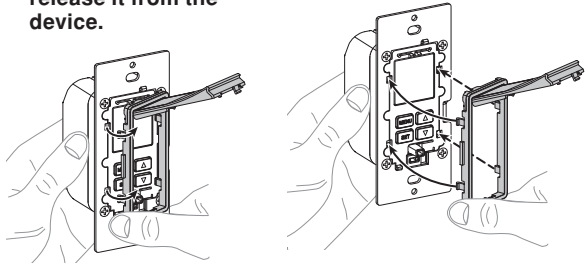

1

5

Identify Your Wires

WARNING: TO AVOID FIRE, SHOCK, OR DEATH, TURN OFF POWER at circuit breaker or fuse and test that power is off before wiring!

NOTE: If the wiring in your wall box does not resemble any of these configurations, consult an electrician.

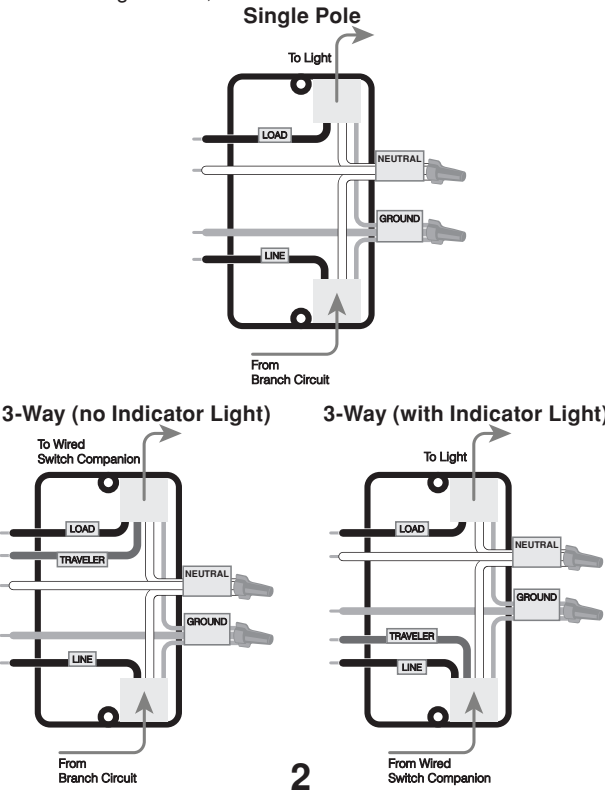

Single Pole

3-Way (no Indicator Light)

3-Way (with Indicator Light)

2

6

Preparing and Connecting Wires:

1. Pull off the pre-cut insulation from timer leads.
2. Make sure that the ends of the wires from the wall box are straight (**cut if necessary**).
3. Remove insulation from each wire in the wall box as shown.

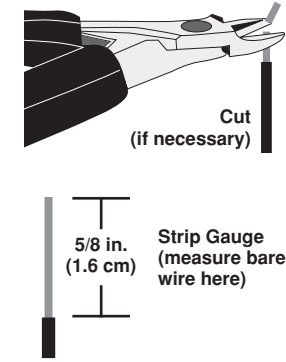

For non-standard wiring applications, refer to the chart below:

WIRE CONNECTOR / # OF CONDUCTOR COMBINATION CHART
1- #12 w/ 1 to 3 #14, #16 or #18
2- #12 w/ 1 or 2 #16 or #18
1- #14 w/ 1 to 4 #16 or #18
2- #14 w/ 1 to 3 #16 or #18

3

7

Single Pole Wiring Application:

1. Work on only one connection at a time.
2. Connect wires as shown, using the included wire connectors.

NOTES: If the label is missing, place electrical tape around the timer switch YELLOW/RED lead. Ensure that no strands are exposed. This wire is used in 3-way installations ONLY. For single pole installations, DO NOT remove insulating label.

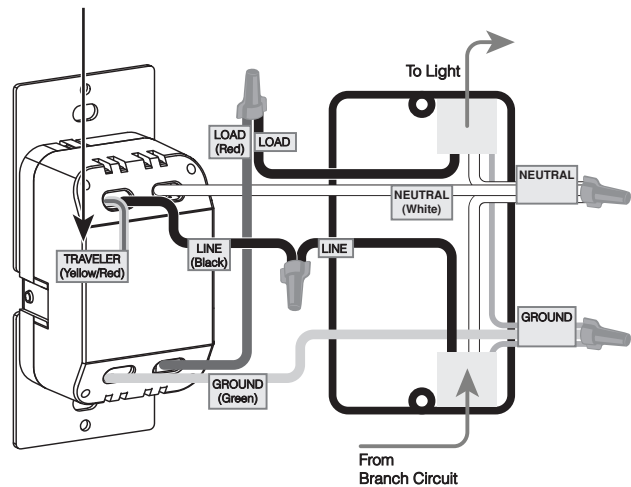

If you are unsure about any part of these instructions, consult an electrician.

4

8

DI-000-VPT24-02H

Cat. No. VPT24-1P, Lighted

Safety First

- WARNINGS:**
- TO AVOID FIRE SHOCK OR DEATH; TURN OFF POWER at circuit breaker or fuse when servicing, installing or removing device.
 - This product is to be installed and/or used in accordance with electrical codes and regulations.
 - If you are unsure about any part of these instructions, consult an electrician.
- CAUTIONS:**
- Use only one (1) digital timer switch in a multi-location circuit with up to 9 wired switch companions (without LED) or up to 4 wired switch companions (with LEDs).
 - Maximum wire length from digital timer switch to all installed wired switch companions cannot exceed 300 ft (90 m).
 - Recommended minimum wall box depth is 2-1/2 in.
 - Use this device with **copper or copper-clad wire only**.

Limited 5 Year Warranty & Exclusions

FCC COMPLIANCE STATEMENT
This device complies with Part 15 of the FCC Rules. Operation is subject to the following two conditions: (1) this device may not cause harmful interference, and (2) this device must accept any interference received, including interference that may cause undesired operation of the device. This equipment has been tested and found to comply with the limits for a Class B Digital Device, pursuant to Part 15 of the FCC Rules. These limits are designed to provide reasonable protection against harmful interference in a residential installation. This equipment generates, uses, and can radiate radio frequency energy and, if not installed and used in accordance with the instructions, may cause harmful interference to radio communications. However, there is no guarantee that interference will not occur in a particular installation. If this equipment does cause harmful interference to radio or television reception, which can be determined by turning the equipment OFF and ON, the user is encouraged to try to correct the interference by one or more of the following measures:

- Reorient or relocate the receiving antenna.
- Increase the separation between the equipment and the receiver.
- Connect the equipment into an outlet on a circuit different from that to which the receiver is connected.
- Consult the dealer or an experienced radio/television technician for help.

FCC CAUTION
Any changes or modifications not expressly approved by Leviton Manufacturing Co., Inc., could void the user's authority to operate the equipment.

IC STATEMENT
This device complies with Industry Canada license-exempt RSS standard(s). Operation is subject to the following two conditions: (1) this device may not cause interference, and (2) this device must accept any interference, including interference that may cause undesired operation of the device.

Patents covering this product, if any, can be found on Leviton.com/patents.
For Leviton's limited product warranty, go to www.leviton.com. For a printed copy of the warranty, call 1-800-824-3005.

FOR CANADA ONLY
For warranty information and/or product returns, residents of Canada should contact Leviton in writing at Leviton Manufacturing of Canada ULC to the attention of the Quality Assurance Department, 165 Hymus Blvd, Pointe-Claire (Quebec), Canada H9R 1E9 or by telephone at 1 800 405-5320.

Leviton Manufacturing Co., Inc.
201 North Service Road, Melville, NY 11747
© 2021 Leviton Manufacturing Co., Inc. All rights reserved.
Specifications subject to change at any time without notice.

3-Way Wiring with Wired Switch Companion, VP0SR-10, (no Indicator Light) Application:

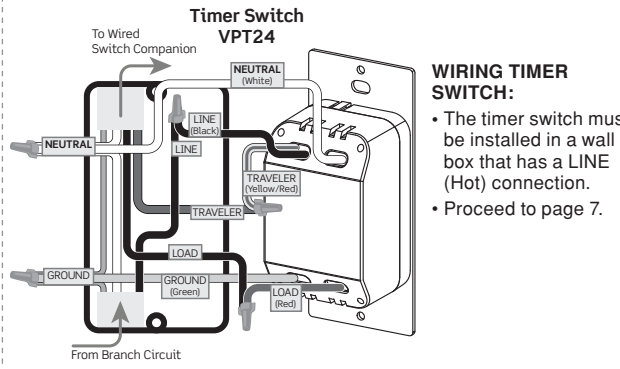
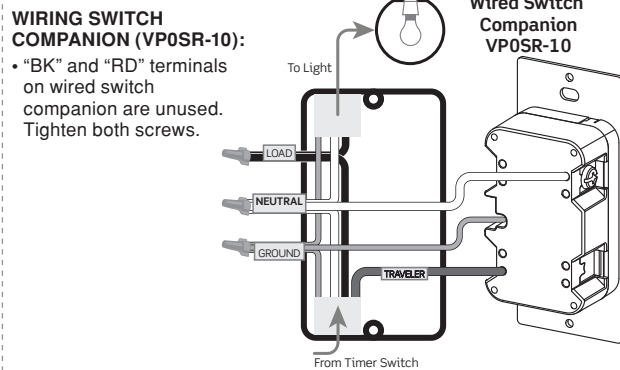

NOTE: Maximum wire length from timer to all installed wired switch companion cannot exceed 300 ft (90 m).

If you are unsure about any part of these instructions, consult an electrician.

5

3-Way Wiring with Wired Switch Companion, VP0SR-1L, (with Indicator Light) Application:

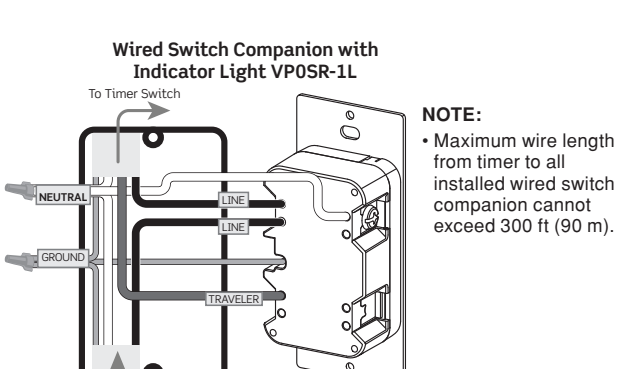
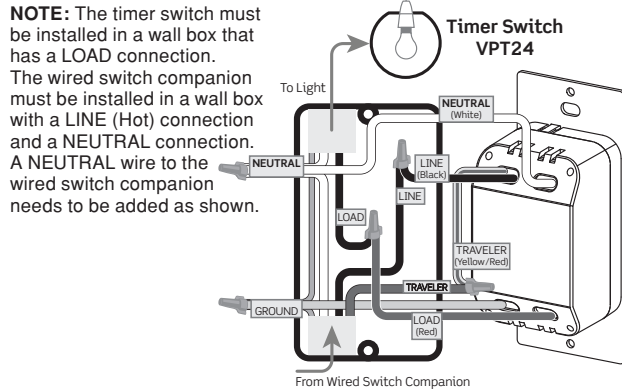

NOTE: Maximum wire length from timer to all installed wired switch companion cannot exceed 300 ft (90 m).

If you are unsure about any part of these instructions, consult an electrician.

6

Test and Install

1. Position all wires to provide room in outlet wall box for device.
 2. Partially screw the mounting screws into the wall box mounting holes.
 3. Restore power at the circuit breaker or fuse.
 4. Wait until **MODE** or the time appears on screen.
 5. Press push pad until locator light turns OFF. Load should turn ON.
- NOTE:** If Loads do not turn ON, refer to the "What to do if..." section on pg. 18.

WARNING: Turn off power at the circuit breaker before screwing in your switch.

6. Tighten mounting screws into wall box.

7. Snap on wallplate and restore power.

7

Understanding Your Device

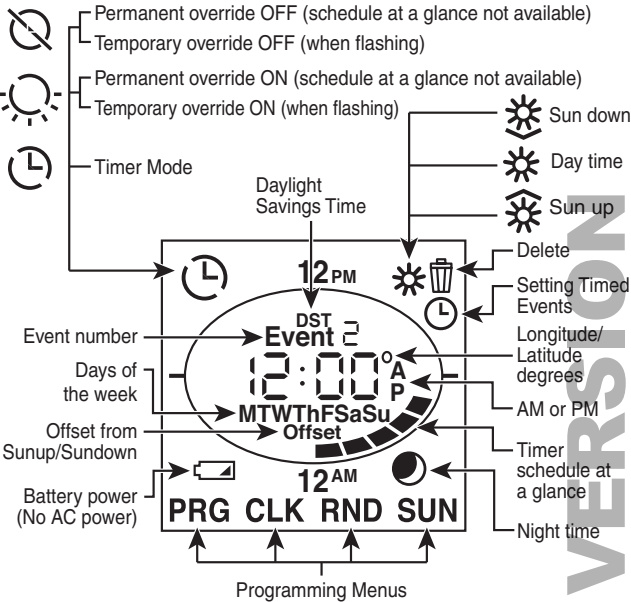

PRG = Programming **RND** = Random Mode
CLK = Clock **SUN** = Sunup/Sundown

Timer Schedule at a Glance allows you to quickly see when your device will turn ON or OFF for the day. The displayed segments represent the time(s) your device will be on. The segment representing the current time will be flashing.

Backlit LCD display will light up when any button is pressed and will turn off 30 seconds after last button is pressed.

8

Programming Guide

Decide which mode is best for your application:
Pro or Standard (Std)

NOTE: To exit programming at any time, press the **OVERRIDE** button.

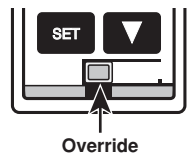

PRO MODE allows you to set up to 49 ON/OFF events for any day of the week or for a combination of days (**M-Su** / **M-F** / **Sa-Su**), at fixed times of your choice, or at self-adjusting times such as **Sunup and Sundown**. Pro Mode enables self-adjusting **Daylight Savings Time** mode.

STANDARD MODE (Std) allows you to set up to 3 ON/OFF events for **M-Su**, **M-F**, or **Sa-Su**, at desired fixed times ONLY.
NOTE: Self-adjusting **Sunup**, **Sundown**, and **Daylight Savings Time** are NOT available in Standard Mode.

To Program Your Device:

- Perform a **System Reset** by gently lifting the door on the face of the device, from the bottom of the push pad, until an audible click is heard. The door will stay open while you are programming the device.
- Press and hold **SET**. Then, also press the **OVERRIDE** button (see above) at the same time. Hold both buttons down until **Del** (Delete) stops flashing and **Rst** (Reset) starts flashing (approximately 5 seconds). Press **SET** to confirm **Reset**.
- Product will go through a brief self-test and then **Mode** will begin to flash. Use the **UP** or **DOWN** arrow buttons to choose either the **Pro** or **Std** mode, and then press **SET** to confirm.
- Continue to either the **Programming: Pro Mode** section (on pg. 10) or the **Programming: Standard Mode** section (on pg. 16), based on your selection.

9

Programming: Pro Mode

1. **TIME:** Digits will start flashing.

- Use to select the current hour.
- Press to confirm your selection.
- Repeat these steps to select the minutes and then **AM (A)** or **PM (P)**.

2. **DAYLIGHT SAVINGS TIME (DST):** OFF will start flashing.

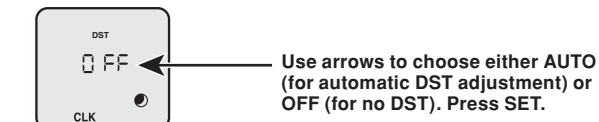

NOTE: DST starts at 2AM on the second Sunday of March (adds 1 hour) and ends at 2AM on the first Sunday of November (subtracts 1 hour).

3. **DATE:** 20-- (first two digits of year) will appear on screen.

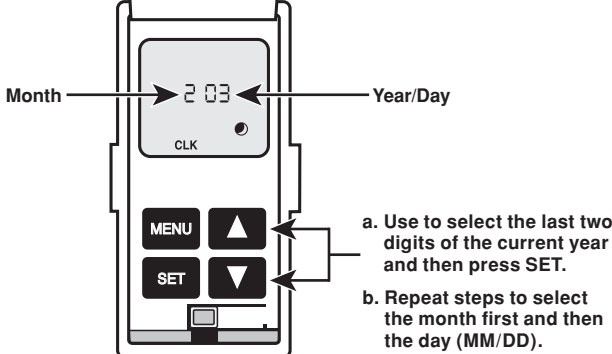

NOTE: The day of the week will automatically adjust.

10

Programming: Pro Mode (continued)

4. **SUNUP & SUNDOWN:**

You will need to enter the coordinates of your location so that **Sunup** and **Sundown** can be automatically adjusted to turn ON or OFF.

- Visit: www.leviton.com/VPT24
- Click on **Longitude/Latitude Coordinates Lookup...**
- Type in your street address and click on **Find LAT/LNG.**
- Your latitude (N) and longitude (W) coordinates will appear above the map. Write down ONLY the 2 or 3 digit number. Disregard any numbers after the period and any negative symbol (-).

NOTE: The time zones are limited to the North American continent and are determined based on your longitude.

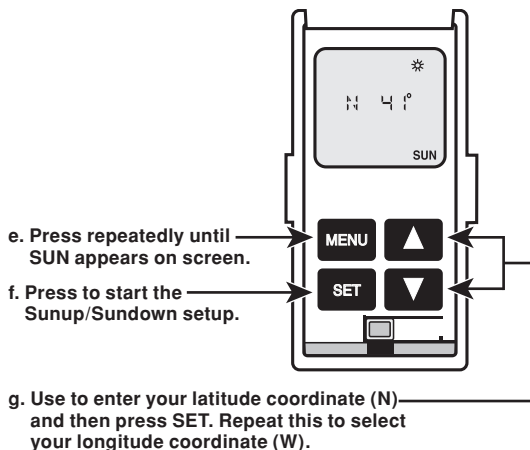

11

Programming: Pro Mode (continued)

5. **OFFSET TIME (optional):** This will affect the Start Time for both Sunup and Sundown. Digits will start flashing.

NOTE: Press **SET** to skip the setup for this feature.

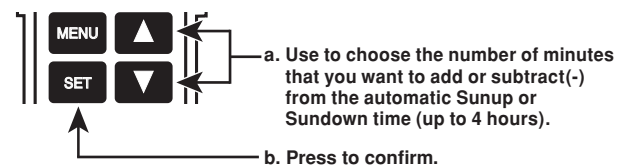

NOTE: When subtracting time, a negative symbol (-) will appear before the time duration.

6. **TIME ZONE:** ZONE will appear on the screen. The Time Zone closest to the coordinates you entered will start flashing.

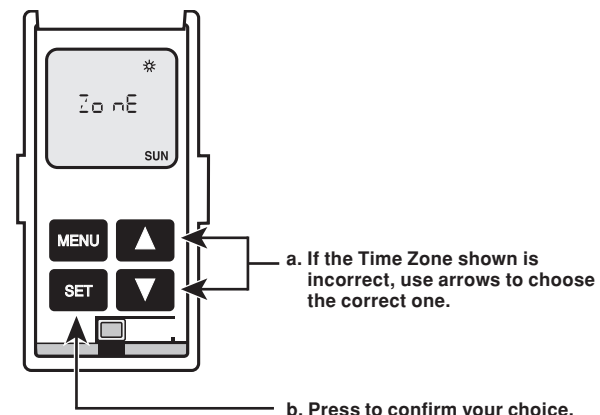

12

Programming: Pro Mode (continued)

7. **ON/OFF EVENTS:**

Set up Event(s) to schedule the days of the week and specific times you want the device to turn ON or OFF automatically.

a. Press repeatedly until **PRG** appears on screen and press **SET**. Event 1 will start to flash.

b. Press **SET** to select Event 1.
NOTE: To select a different Event number, use **Up** arrow to move to next event and press **SET**.

c. All the days of the week will start flashing. Press **SET** to choose all days for the Event.

OR
Use arrows to scroll through all the options to select either a single day or a combination of days for the Event. Press **SET** on your desired day(s).

NOTE: To choose a combination of days, use the arrows to select one day at a time and press **SET** after each day that is selected.

13

Programming: Pro Mode (ON/OFF EVENTS continued)

8. To set the **Event ON-Time**, use the arrows to choose one of the following options and then press **SET**:

Clock (Set a specific ON-Time)

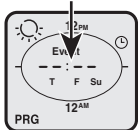

Sunup

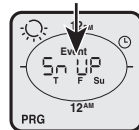

Delete an existing ON-Time

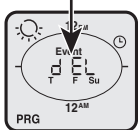

Sundown

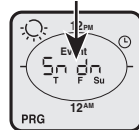

If **Clock** is selected, follow the steps below.

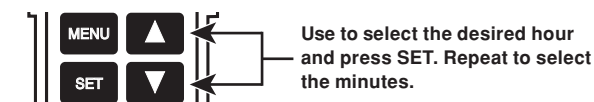

14

Programming: Pro Mode (ON/OFF EVENTS continued)

9. The **Event OFF-Time** will appear on screen as **6:00P** (default).

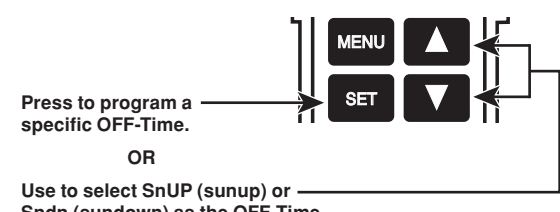

NOTE: To delete an existing Event OFF-Time, press **Del**.

If you pressed **SET**, the OFF-Time will default to **6:00P**. To change this time, follow the steps below:

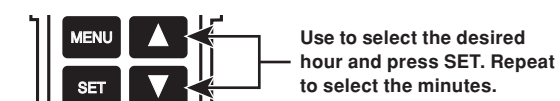

10. **Set up another Event (Optional):** Choose the next Event number and follow the same process (Steps 7-9).
NOTE: You can set up to 49 events in Pro Mode.

11. **Exit Programming Mode:** When done setting up Events, press the **Override** button to exit. Device will automatically exit after 30 seconds of inactivity.

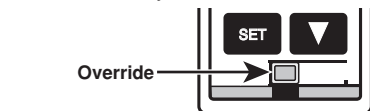

15

Programming: Standard (Std) Mode

1. **TIME & DAY:** Digits will start flashing.

NOTE: Daylight Savings Time is NOT available in Standard mode.

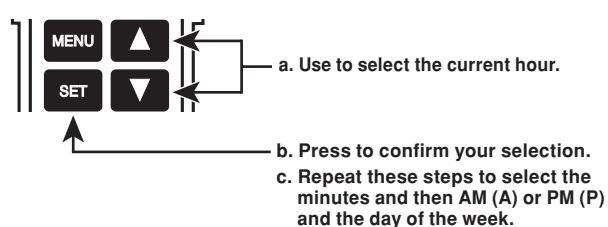

2. **ON/OFF EVENTS:**

Set up Event(s) to schedule the days of the week and specific times you want the device to turn ON or OFF automatically.

a. Go to pg. 13 and follow steps 7-11 to set up to 3 Events.

NOTES:

- Sunup and Sundown are NOT available for ON/OFF Event times in Standard mode. They are for Pro mode ONLY.
- In standard mode, the days of the week will be limited to M-F, S-Sun, everyday.

16

Timer Overrides

- Activate Temporary Override by pressing the push pad to toggle the Load (ON to OFF or OFF to ON).
- Activate Permanent Override by pressing and holding the push pad for several seconds to maintain the Load in the current state (either ON or OFF).

Changing Settings

1. **Change the Time:** Press **MENU** repeatedly until **CLK** appears on screen, and then press **SET**. Adjust the clock using the arrows, and press **SET** after each setting.

2. **Turn Random Mode ON/OFF**

This function will add or subtract anywhere from 1 to 20 minutes to each selected **ON** and **OFF** time to create a random pattern.

- Press **MENU** repeatedly until **RND** appears on the screen and press **SET** to enter this mode.
- Use arrows to toggle between **OFF/ON** and press **SET**.



Use in Multi-Location Applications

When using a wired switch companion with your 24-hour timer, you will be able to activate the Temporary Override or the Permanent Override from the wired switch companion. To activate or deactivate the Temporary Override, press the push pad on the wired switch companion. To activate the Permanent Override, press and hold the wired switch companion push pad. Either of these actions will toggle the state of the Load.

17

Delete All Events

If at any time you want to delete all of your programmed events, you can perform a **DELETE ALL EVENTS** function:

- Lift the VPT24 door from the bottom of the push pad until an audible click is heard.
- Press and hold **SET**, followed by the **Override** button, until **dEL** stops flashing. Upon releasing both buttons, all events will be deleted, and the **Timer Schedule at a Glance** will appear with only the current time segment flashing.

What to do if...

Lights are flickering or there is intermittent power to LOAD:

- Check if the LOAD has a bad connection.
- Make sure that wires are secured firmly with wire connectors of the timer switch or terminal screws of the wired switch companion.

LOAD does not turn ON and Locator LED does not turn ON:

- Check if the circuit breaker or fuse has tripped.
- Check if the LOAD has burned out.
- Make sure the LOAD NEUTRAL connection is wired.

Wired switch companion does not operate lights:

- Ensure that total wire length does not exceed 300 ft. (90 m).

NOTE: The timer switch must be installed in a wall box that has a LOAD connection. The wired switch companion must be installed in a wall box with a LINE (Hot) connection and a NEUTRAL connection. A NEUTRAL wire to the wired switch companion needs to be added as shown.

Scan this code with your cell phone camera to watch a video on how to program your device using the Pro Mode.



Visit leviton.com/vpt24 or contact Technical Services at 1-800-824-3005 for additional help.

18